



**Material comminution
Process system**

Comprehensive solution provider

LEEJUN

Address: 16 Raffles Quay #17-03 Hong Leong Building Singapore 048581

Tel: +65 6568 8876

Website: www.osleejun.com

Email: info@osleejun.com

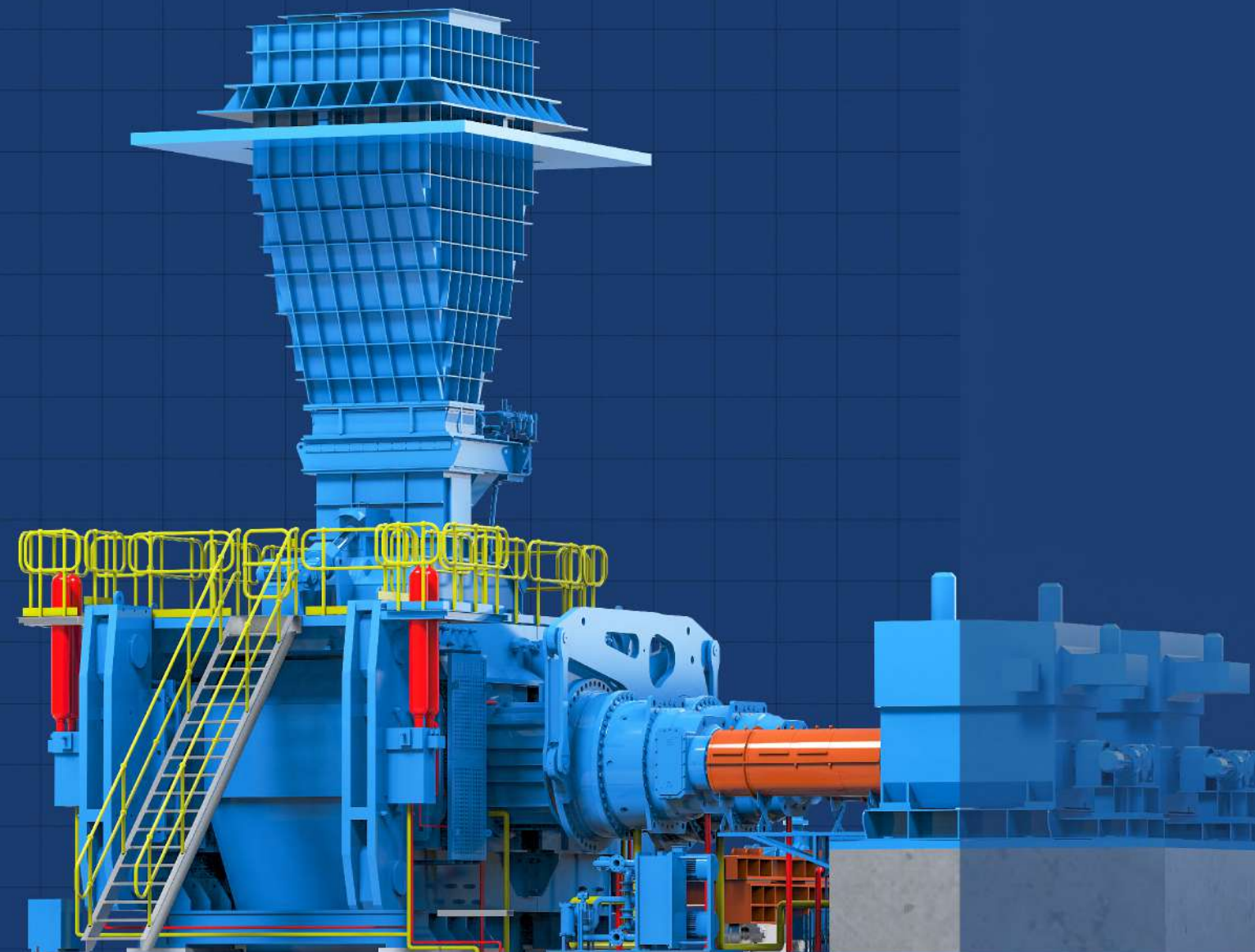

About LEEJUN (Chengdu Leejun Industrial Co., Ltd.)

Specialized in the R&D, manufacturing, sales and services of the comprehensive solutions and core equipment for the grinding systems in the industries of cement and building materials, metal mines, ferrous metallurgy and chemical industries.

The only A-share listed company of energy-saving grinding system equipment with the core products of High Pressure Grinding Rolls (HPGR)/Roller Presses in China (stock code: LEEJUN 002651).

Main business:

Providing comprehensive solutions and supplying key equipment for the material grinding and separation system, including HPGR -the critical core equipment of the grinding system, Ultra-fine Dry Classifying Screen, Dry Magnetic Separator and New-type Separator for mines.

Engineering, equipment procurement and even EPC.

Over years of R&D, with tremendous strength of innovation and pursuit of the highest product quality, our products have been sold locally and internationally, providing efficient, high-quality and convenient services for the customers in nearly 40 countries and regions.

With growing demand from the international customers, LEEJUN established a wholly-owned subsidiary in Singapore in 2014. Since then, Leejun Holding (Singapore) Pte Ltd has constantly invested resources for expansion, growing into a comprehensive solution provider for the Roller Press/HPGR system for the overseas greenfield / brownfield projects.



The HPGR of LEEJUN has been awarded with the
"National Single Champion Product in Manufacturing"

by the Ministry of Industry and Information Technology of
the People's Republic of China.



LEEJUN—Core equipment

High Efficiency

HPGR

Ultra-fine Dry Classifying Screen

Dry Magnetic Separator

New-type Separator for mines

System energy saving of over **50%**

Millions of tons

of carbon emission reduced each year

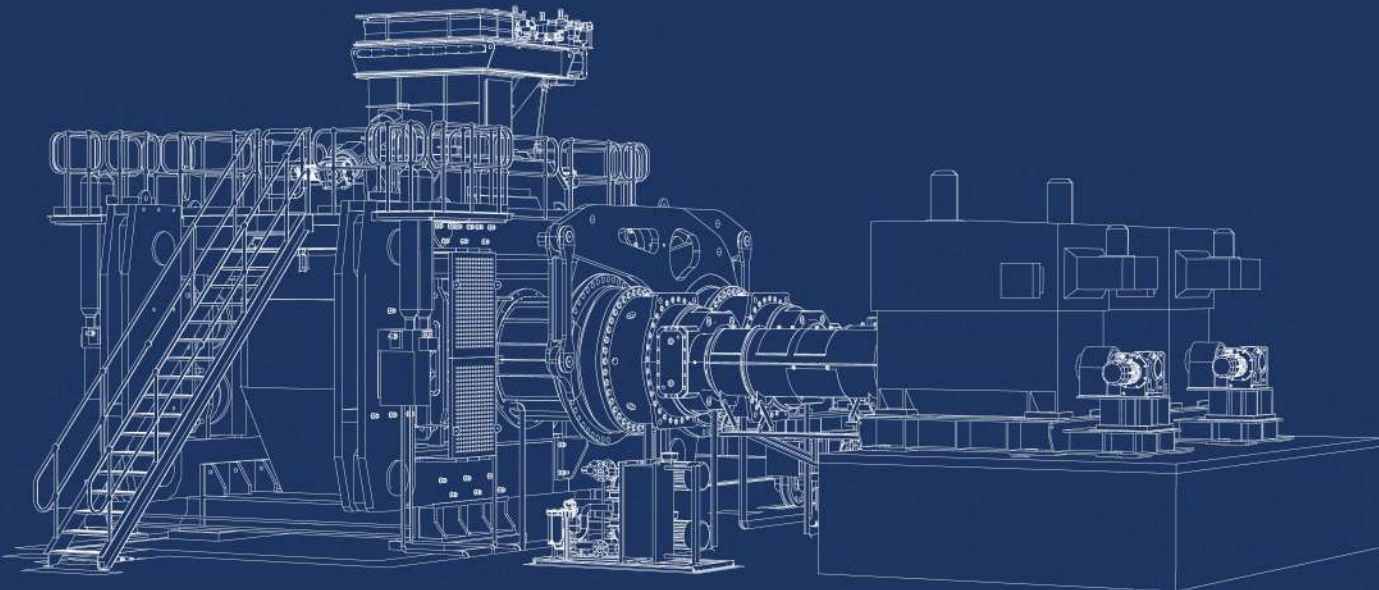

CLM Series HPGR

Structure Diagram

- 1 Maintenance Trolley (optional)
- 2 Winch System (optional)
- 3 Fixed Roller Assembly
- 4 Floating Roller Assembly
- 5 Feed Gate
- 6 Maintenance Guardrail
- 7 Main Frame
- 8 Torque Support
- 9 Gearbox
- 10 Gearbox Lubrication System
- 11 Universal Coupling & Safety Hood
- 12 Hydraulic System
- 13 Main Motor
- 14 Motor Base

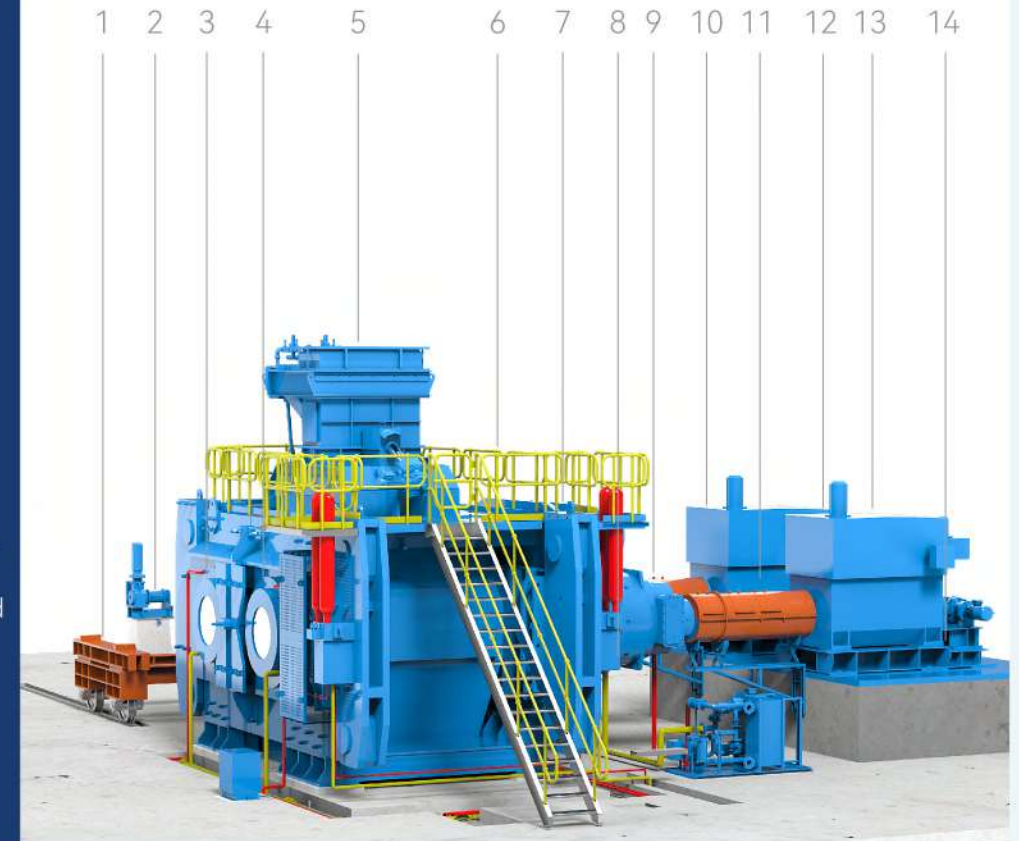

CLM Series HPGR | Table of Main Technical Parameters

Series	Roller diameter	Roller width	Throughput	Max. feed size	Main motor power
CLM120	1200 mm	500-800 mm	200-400 t/h	≤30 mm	2×250-2×400 kW
CLM150	1500 mm	600-1200 mm	400-900 t/h	≤35 mm	2×450-2×900 kW
CLM170	1700 mm	700-1400 mm	650-1300 t/h	≤40 mm	2×630-2×1250 kW
CLM200	2000 mm	800-1600 mm	900-2300 t/h	≤50 mm	2×1000-2×2240 kW
CLM240	2400 mm	1000-1700 mm	2000-4000 t/h	≤60 mm	2×1800-2×3150 kW
CLM260	2600 mm	1200-1800 mm	2700-5000 t/h	≤65 mm	2×2500-2×4000 kW
CLM300	3000 mm	1400-2200 mm	4300-7200 t/h	≤75 mm	2×3550-2×6300 kW

※ The above technical parameters are obtained by taking the iron ore (true density of 3.3t/m³, and medium hardness) as an example, only for reference for model selection. The specific selection parameters shall be based on the experimental data, and will be provided after design of the process plan.

CLM Series HPGR

Ordinary/segmented stud rollers

Traditional-sleeve stud rollers and new segmented-sleeve stud rollers are available

Ordinary stud roller

Mainly composed of roller shaft, cylindrical roller sleeve and studs (embedded on the surface of roller sleeve) for material grinding.

- **Greater improvement of overall abrasion performance** – LEEJUN unique diamond-shaped dot-matrix layout allows the formation of a dense "autogenous wearing layer" between studs, effectively protecting the roller body from abrasion, and greatly extending the service life of roller sleeve.
- **Strong material adaptability** – Stable operation for materials with different moisture, particle sizes and hardness, easily handles various kinds of hard rock ores, such as iron ore and non-ferrous minerals.
- **Easier maintenance and low maintenance cost** – If any studs are accidentally broken or fractured in operation, maintainers who have simple maintenance and skills training, will be capable of self-replacement by taking advantage of the equipment shutdown interval. Timely maintenance will ensure the normal use of the roller surface and achieve the maximum service life.



Segment type stud roller

Mainly composed of roller shaft, segmented sleeve and studs. Segmented sleeve contains several identical pieces divided from the traditional cylindrical sleeve along the circumference. Studs are embedded on the surfaces of the segmented sleeve installed on the roller shaft along the circumference.

While having the advantages of the ordinary stud roller, the segment type stud roller also has the following strengths:

- **Quick online replacement and convenient disassembling and assembling** – No need to disassemble and assemble the frame, bearing housing and other parts. This means less man-hour with short downtime
- **Wide application scope** – Different wear-resistant materials are customized based on the characteristics of different materials
- **Light weight of single piece** – Convenient for transportation, installation, and storage of wearing parts

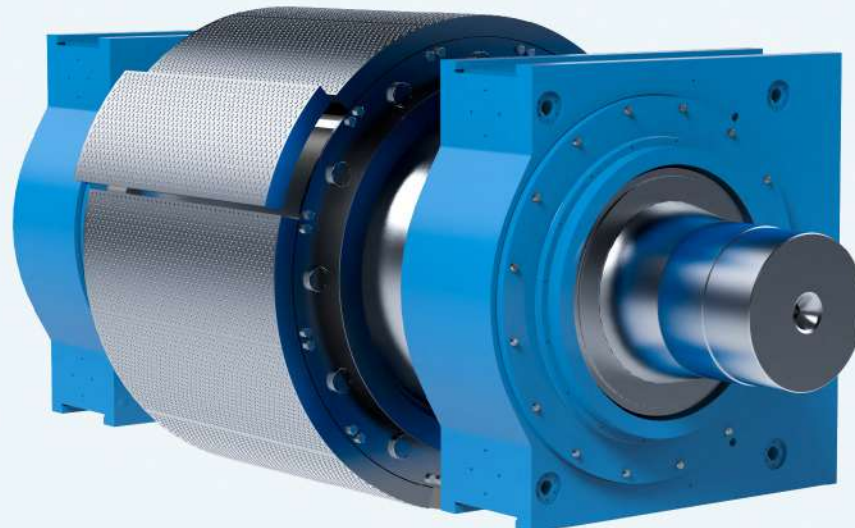

CLM Series HPGR

Open-combined frame & side pull system



LEEJUN adopts the open-combined frame and side pull system for the HPGR maintenance. The roller assemblies are maintained by the rail+maintenance trolley+winch system, greatly simplifying the maintenance of the roller assembly of large HPGR, saving the maintenance time, and reducing the investments in maintenance equipment and infrastructure.

CLM Series HPGR

Dedicated sliding bearing

- **Unique dedicated sliding bearing** – longer service life and suitable for large HPGR
- **The sliding bearing is lubricated with oil** – Good cooling effect, sufficient lubrication, strong self-cleaning ability, and capability of taking away the fine powder produced by wear
- **Convenient maintenance** – no need bearing shoe grinding, less wearing parts which can be replaced without dismantling the frame and gearbox

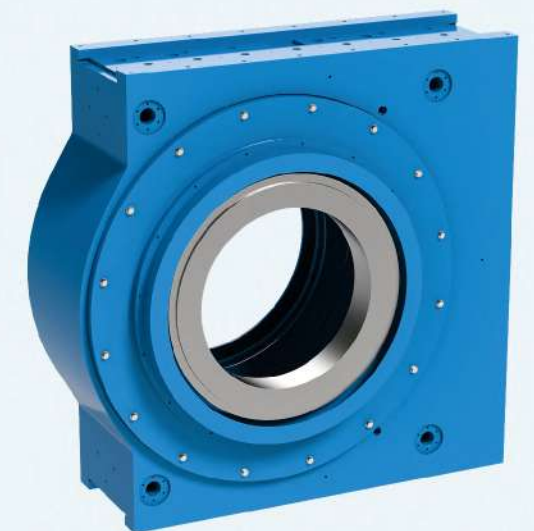

CLM Series HPGR

Hydraulic Systems



With German brand OEM auxiliary components as the core, LEEJUN has independently designed and manufactured the hydraulic system based on the concept of "constant roller gap control within a certain pressure range", minimizing the tripping caused by the roller gap difference out of tolerance, which is more efficient and reliable.

The hydraulic system cooperates with the automatic control system, achieving the control over the gap deviation between two rollers and the automatic skewing correction.

CLM Series HPGR

Intelligent cloud system

Advantages of the intelligent cloud system of LEEJUN:

- **Self-perception** – Real-time monitoring of equipment operation and dynamic data analysis
- **Self-adaptation** – The equipment itself is able to adjust its running state at any time to adapt to the properties of ore materials
- **Self-learning** – Learn to establish the comparative analysis model of roller surface studs and to formulate the specific maintenance measures
- **Self decision-making** – Automatically control the process parameters of equipment and system, and make correct and timely equipment operation decisions

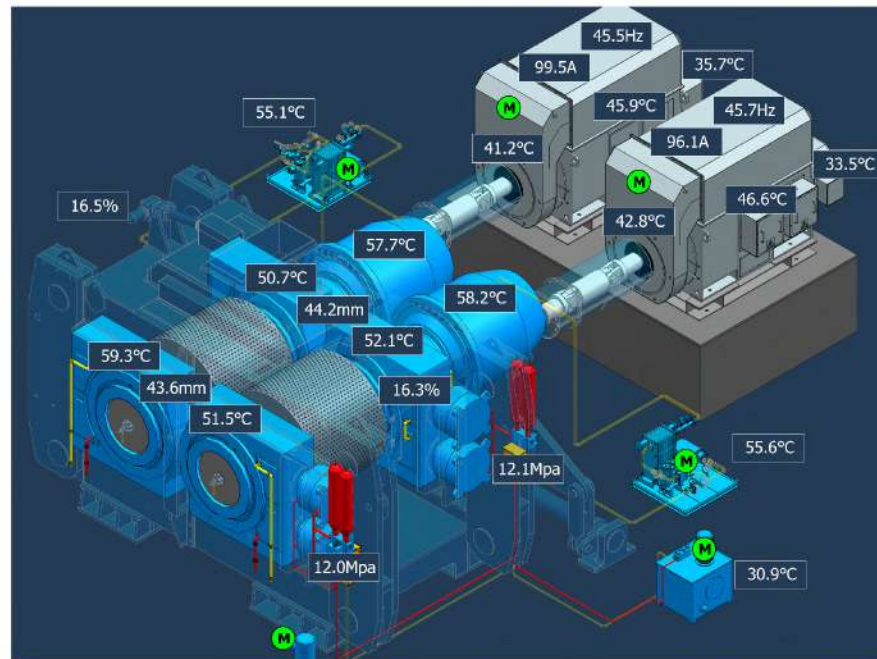

HZ Series Ultra-fine Dry Screen

Function Introduction

The efficient ultra-fine dry screen specially developed for HPGR is capable of ultra-fine screening of 0.5mm materials, and the single processing capacity reaches 1,000t/h at least.

- With the efficient and ultra-fine particle classifying patented screen surface technology and the anti-blocking design of screen holes, the screening efficiency is more than 85%
- High-frequency, low-amplitude and high excitation force design
- Excellent combined screen surface design, effectively extending the service life of screen
- Ultra-high frequency vibration, without blocking of screen holes
- Secondary vibration isolation, almost without impact on the foundation
- High precision vibration exciter, with the noise lower than 80dB
- Complete set of sensors, with screening parameters accessed to PLC and unattended mode
- Simple screen plate installation, and modular design
- Fully sealed structure of screen, resulting in excellent dust prevention and collection
- Compact structure, less space occupation, and investment saving



HZ Series Ultra-fine Dry Screen | Table of Main Technical Parameters

Specification & model	Processing capacity	Feed size	Feed moisture	Lower screen aperture	Screening efficiency	Motor power
HZ500A	400-700 t/h	< 75 mm	≤4%	0.5 mm	> 85%	30×2+15×2 kW
HZ850A	700-900 t/h	< 75 mm	≤4%	0.5 mm	> 85%	37×2+15×2 kW
HZ1000A	900-1100 t/h	< 75 mm	≤4%	0.5 mm	> 85%	45×2+22×2 kW
HZ1250A	1100-1400 t/h	< 75 mm	≤4%	0.5 mm	> 85%	55×2+22×2 kW
HZ350B	600-800 t/h	< 75 mm	≤4%	0.5 mm	> 85%	30×2 kW
HZ500B	900-1100 t/h	< 75 mm	≤4%	0.5 mm	> 85%	37×2 kW

※ The above selection parameters are only for reference. The specific selection parameters shall be based on the experimental screening data, and will be provided after design of the screening process plan.

PDM Series Dry Magnetic Separators

Function Introduction

Introduction to the strengths and characteristics of the PDM series ore fines dry separators:

- Developed for the dry separation of the micro-fine particle materials. Unique magnetic system design and the rotating gradually varied magnetic field. Effectively solves the problem of the fine particle inclusions during the dry separation to obtain high grade dry separation concentrates and to simultaneously discard the qualified tailings.
- Applicable to the dry magnetic separation of magnetite and other materials less than 3mm. Combined with the HPGR process, concentrates, middlings and tailings can be obtained after the primary grading. Besides, the middlings can be returned to the HPGR for grinding again, further improving the ore liberation degree and concentrate grade, and also reducing the loss of magnetic iron in tailings.
- Large processing capacity, simple structure, convenient maintenance and good sealing properties. With energy and water conservation, the permanent magnet system is adopted, without the consumption of magnetizing current, and the equipment operation cost is low. In the meantime, dry separation is adopted to save water.
- For energy conservation, the permanent magnet system is adopted. Without the consumption of magnetizing current, and the equipment operation cost is low. For water conservation, dry separation is adopted.



PDM Series Dry Magnetic Separators | Table of Main Technical Parameters (Partial)

Specification & model	Drum diameter × width	Feed moisture	Throughput	Feed size	Motor power
PDM1200/2000	1200×2000 mm	≤1%	150-250 t/h	0-3 mm	15+30 kW
PDM1200/3500	1200×3500 mm	≤1%	300-500 t/h	0-3 mm	30+55 kW

※ The above technical parameters are only for reference. The specific selection parameters shall be based on the experimental data, and will be provided after design of the process plan.

CLXT Series Separator For Mining

Function Introduction



Applied in the industry of metallurgical mine, for high-density materials and micro-fine particle dry classification

- The central feeding and improved spreading tray enable that materials are more evenly distributed with high efficiency of powder separation
- With the lower air outlet structure, the feeding capacity and output are larger under the same air volume condition, and the power consumption of system is reduced
- The rotor height is properly increased, prolonging the particle separation, improving the efficiency of powder concentrator, and enabling more stability in the grading performance
- Compact structure, aerodynamics optimal design, low resistance of equipment, and low power consumption
- Simple operation, convenient fineness adjustment, and low equipment maintenance cost

CLXT Series Separators for Mining | Table of Main Technical Parameters (Partial)

Specification & model	Air volume	Feed volume	Finished product output	Finished product fineness	Motor power
CLXT2650	255000-345000 m³/h	638-863 t/h	255-345 t/h	P80≤0.074 mm	160 kW
CLXT40120	612000-828000 m³/h	1530-2070 t/h	612-828 t/h	P80≤0.074 mm	280 kW

※ The above technical parameters are only for reference. The specific selection parameters shall be based on the experimental data, and will be provided after design of the process plan.

HPGR

For iron ore and nonferrous metal industries to replace the tertiary crushing

The HPGR replaces the traditional tertiary crusher, reducing the material size into roller and steel consumption of ball mill, thus largely improves the efficiency of ball mill. Particularly for the low-grade iron ore, the pre-separation is added before ball mill, improving the ore grade before ball mill and discarding a large number of qualified tailings in advance. The comminution concept of "more crushing and less grinding, and discarding as early as possible" has been achieved.

There are three processes below available for the HPGR:

- One pass open circuit
- Side material circulation
- Closed circuit screening

"Closed circuit screening + pre-magnetic-separation" is the mainstream process of iron ore at present. The followings are available depending on different scenarios of customers (such as different material moisture):

- Dry screening + dry magnetic separation
- Dry screening + wet magnetic separation
- Wet screening + wet magnetic separation

※LEEJUN has application cases of large projects regarding the above process systems

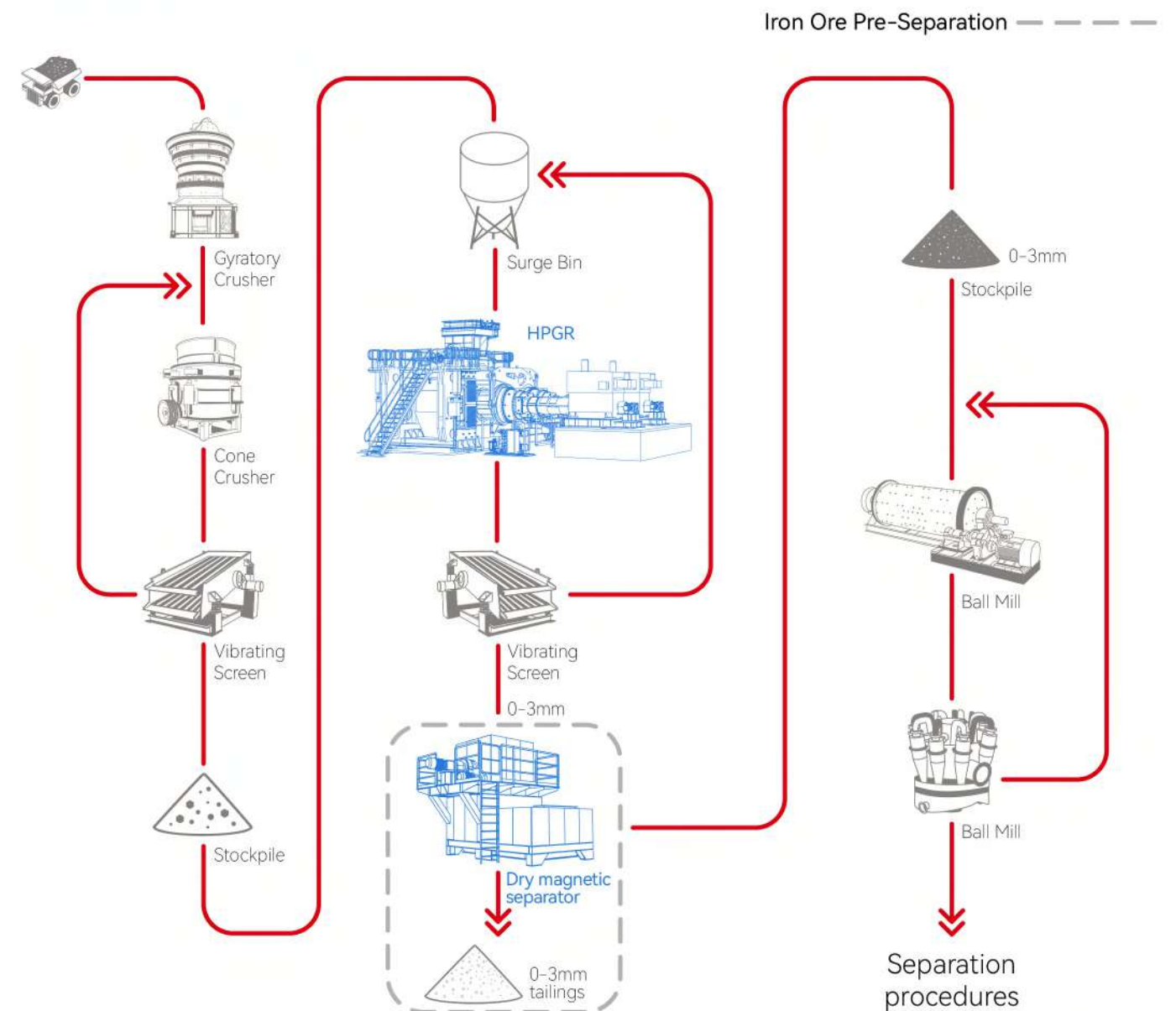

HPGR

For the wet grinding of pellets

The HPGR replaces the traditional ball mill and it is used for the wet grinding of iron concentrate in the pelletizing plant before pelletizing, effectively increasing the specific surface area of iron concentrate, improving the surface activity, **greatly reducing the consumption of bentonite, and improving the pelletizing strength and pelletizing ratio.** It has been the standard configuration of the pelletizing plant.

There are two processes below available:

- One pass open circuit ————
- Side material circulation - - - - -

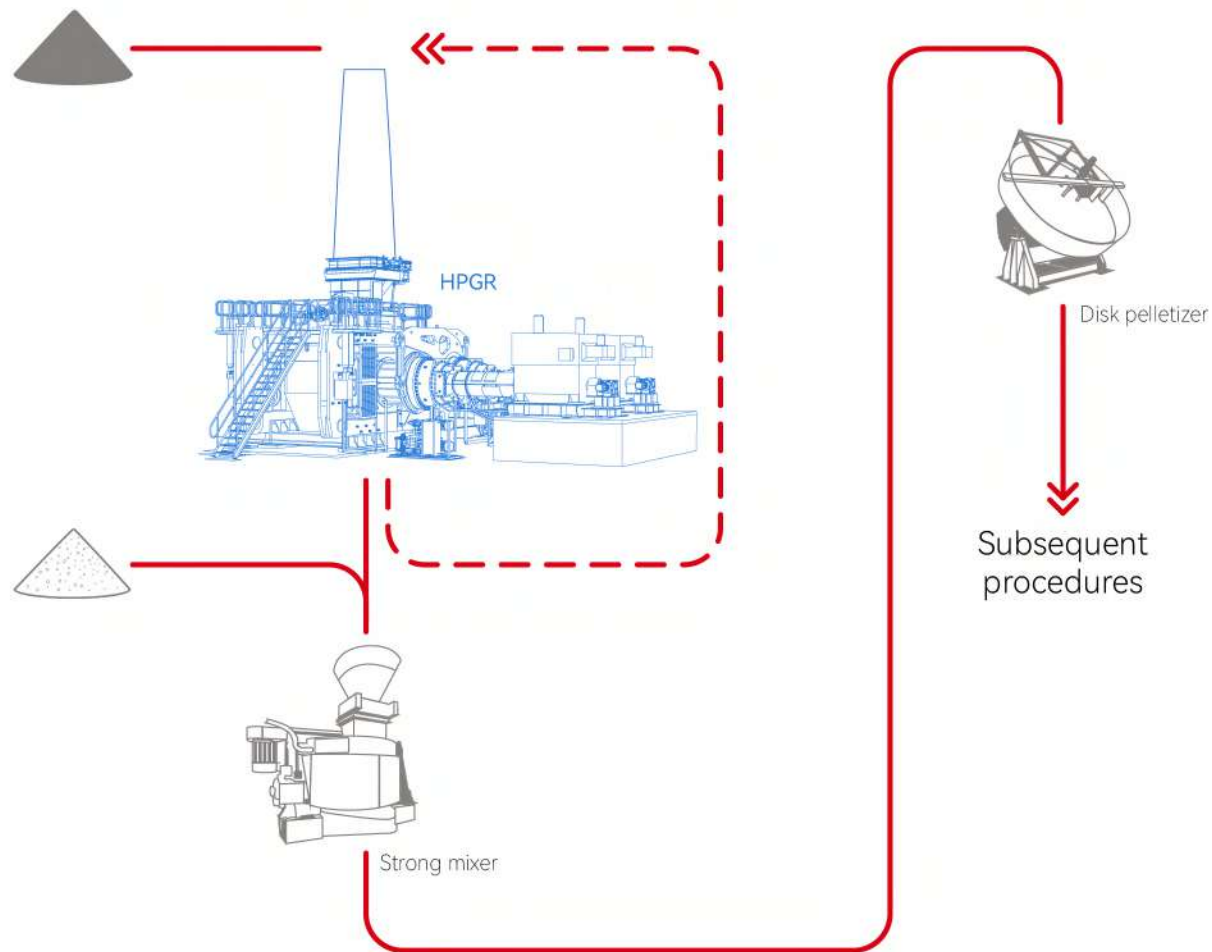

HPGR

For the comminution of pebbles

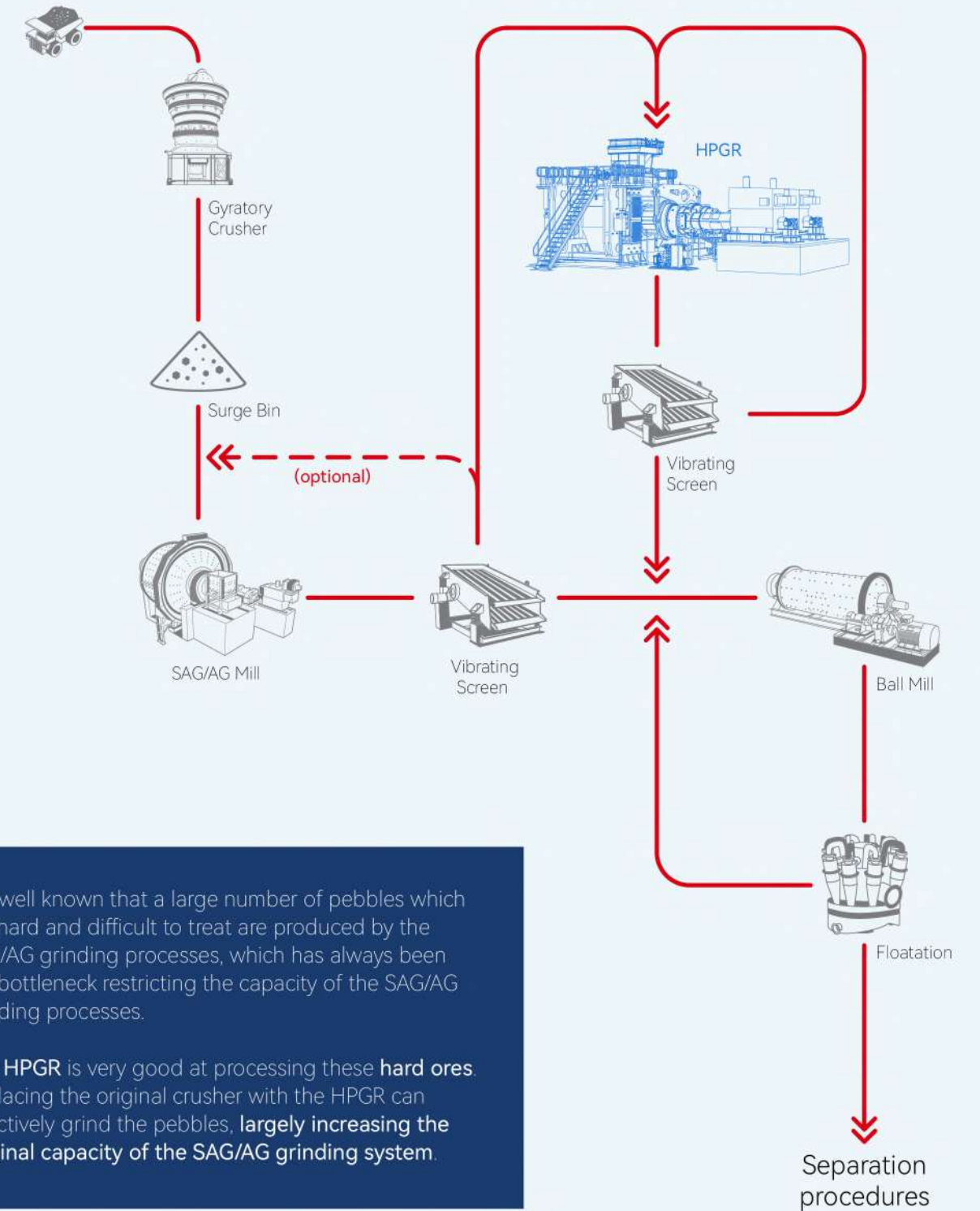

It is well known that a large number of pebbles which are hard and difficult to treat are produced by the SAG/AG grinding processes, which has always been the bottleneck restricting the capacity of the SAG/AG grinding processes.

The HPGR is very good at processing these **hard ores**. Replacing the original crusher with the HPGR can effectively grind the pebbles, **largely increasing the original capacity of the SAG/AG grinding system.**

HPGR

For heap leaching of gold ores

The HPGR replaces the traditional tertiary crusher, and forms a closed circuit with the vibrating screen. A large number of microcracks produced in the gold ores will **largely increase the heap leaching rate and metal recovery rate** and enabling the customers to obtain huge economic value.

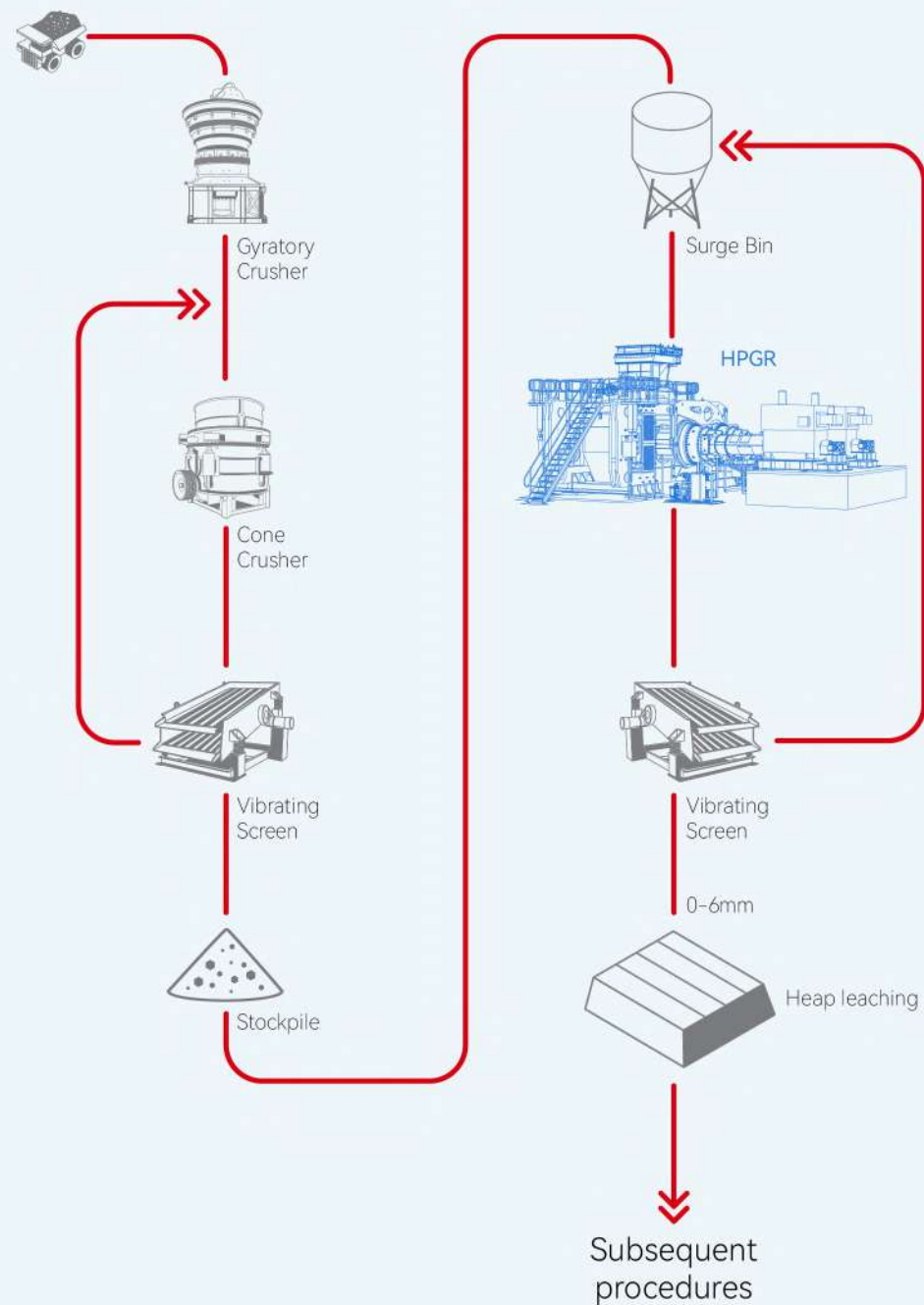

HPGR

Dry grinding, dry separation and finished grinding process system

By adopting the new "ball mill-free and fully dry" material finished grinding process system, it has **minimized the consumption of power, steel and water**, particularly suitable for the areas that are lack of water.

The **ultra-fine screen** and the new-type separator for mining are perfectly matched with the efficient HPGR, which is the **ball mill-free and water-free**, and applicable to both iron ore and nonferrous metal industries.

HPGR

For new process of primary grinding and pre-separation in the iron ore industry

The HPGR replaces the traditional tertiary crusher and the primary ball mill. Combining with **the ultra-fine screen** and **the dedicated dry magnetic separator**, it is able to reduce the material size to 0.5mm before ball mill, improving the ore grade before ball mill, discarding a large number of qualified tailings in advance, and perfectly realized the comminution concept of "**more crushing and less grinding, and discarding as early as possible**". This creates the possibility of the economical development of low-grade iron ore.

HPGR

For new process of primary grinding and pre-separation in the nonferrous metal industry

The HPGR replaces the traditional tertiary crusher and ball mill. The 0-0.5mm materials after dry screening will directly enter the subsequent flotation procedure after pulping (conveyed by the ultra-long pipeline). This can be used for various hard rock ores, such as **lithium ore, copper ore, gold ore, molybdenum ore and lead zinc ore etc.** In case of high moisture of the raw ore, wet screening is allowed. The oversize products will return to the HPGR after dehydration, and the undersize products will directly enter the flotation procedure.

Due to the fine particle size distribution of HPGR and a large number of microcracks generated in the minerals, **the recovery rates of target metals can be increased** in the subsequent flotation procedure.

The HPGR replaces the traditional ball mill with high energy consumption, which will **greatly save energy and reduce consumption** for new concentration plants or upgrading project.

R&D and experiments

Raw material testing and analysis

LEEJUN has established its **Analysis and Testing Center**. It is able to provide the advanced, accurate and reliable **material analysis and test reports for customers**.
Provide the strongest support for the process plan formulation and optimization.

The following types of analysis and testing are available:

- Mineralogy analysis
- Raw material analysis
- Particle size analysis of raw materials
- HPGR testing
- Bond work index
- Service Life test of roller surface
- Full range of minerals processing test
- Specific surface area testing of iron concentrate
- Other types of testing are also available as required by customers...

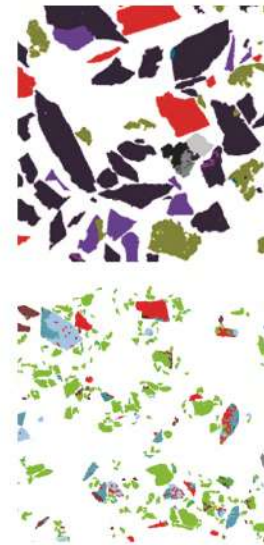

R&D and experiments
Industrial Test



LEEJUN has devoted enormous resources to build multiple **fully-automatic pilot plant test systems**. We can simulate the actual production to provide the reliable industrial test data, so as to formulate the best system solution.



Service system of LEEJUN

Perfect and reliable service teams

One-stop service

Accumulated technical experiences at the sites of thousands of customers, the unwavering professionalism and strong technical and after-sales service teams, LEEJUN is capable of providing customers with a full range of services by just one phone call. These services include pre-sales technical discussion, on-site inspections, equipment installation, system commissioning, operation testing, training, production management, equipment maintenance, and spare parts supply, attending to all your needs.



Provision of System Upgrading, Transformation and Commissioning Services

All-round and professional equipment and system upgrading service assurance. With our leading edge research, and practical experience from thousands of production lines, we can achieve substantial production increase and consumption reduction, more stable operation of system, and significant improvement of economic benefits.



Remote Service System

Unique remote service diagnosis system enables the online real-time testing of the operating status of equipment and systems. Its accurate, intuitive, fast and secured data, low operating costs, and real-time diagnosis by expert teams reliably guarantee the operation of your equipment and systems.



Logistics support

LEEJUN has the first-class warehouse center in the industry, with a building area of more than 30,000m², a modern warehouse capable of storing 40,000 models of parts/60,000 storage spaces, and the professional third-party logistics distribution, so that the products will be delivered to any site in the world in the shortest possible time.

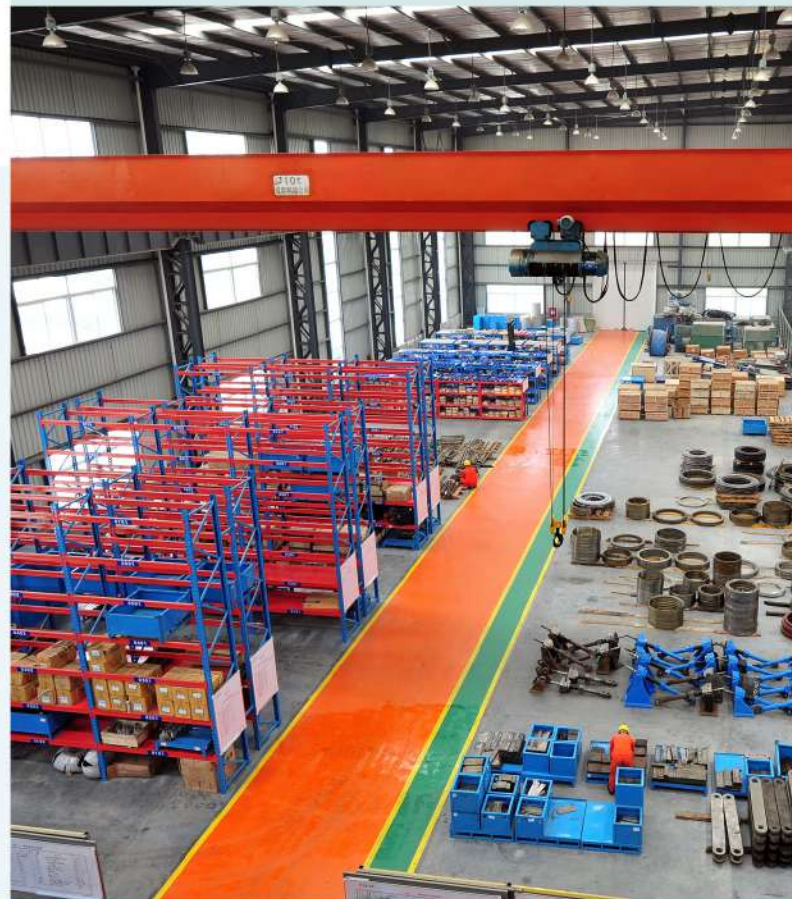

Joint reserve

With a huge customer group, LEEJUN has established a shared centralized warehousing system, and a huge range of spare part reserves are available with less capital investment, thereby reducing the risk of being out of stock.



24 hours service system

24 hours online technical consultant experts providing you with technical supports and services.



Original accessories and quality assurance

LEEJUN implements strict quality control over every production link, from raw material procurement to finished product delivery, and the advanced testing instruments and equipment are equipped to test the various performance indicators of products, and to spot check or thoroughly inspect the finished products and semi-finished products, thus eliminating the non-conforming products in time and ensuring the product quality is in line with requirements.



OEM parts

LEEJUN has set up and fully utilized various purchasing channels, obtained preferential prices with centralized purchasing based on the scale advantages, and inspected and only accept the quality as per the unified standards. Each purchased part has undergone strict testing to guarantee the products are in line with the standards of LEEJUN. LEEJUN provides the technical services and supports to eliminate your worries.



Preventive Maintenance and Online Diagnosis

Offline or online real-time preventive diagnosis of potential issues of roller surfaces, bearings, gearboxes, fans and motors through the diagnostic equipment allows the operating status and service life of the equipment to be fully in control.



Maintenance General Contracting

The general contracting of equipment and system maintenance is provided to assist the customers in obtaining more comprehensive and professional maintenance assurance, reducing the costs of maintenance and equipment operation, and striving for greater economic benefits.



Client training

The on-site training and the centralized training by LEEJUN are adopted, providing the all-round, multi-specialty and multi-level training for customers.





Our Mission

Adhere to harmonious and green development, constantly pursuit of new technologies and processes, further reduce carbon emissions, and save water resources, create a better future.

Our Vision

We aim to be a sustainability leader in our industry, create long-term value for customers and society.

